

- Sürme Kasa Profili (Çift Ray)**  
P.A.222.1100.600
- Destek Sacı (10x31)**  
1,2mm - 34022 - 12107  
1,5mm - 34022 - 15107  
2 mm - 34022 - 20107

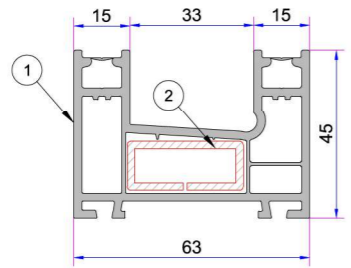

- Çift Raylı Sürme Kasa Profili (Yeni)**  
P.A.222.1111.600
- Destek Sacı (13x31)**  
1,2mm - 34022 - 12126  
1,5mm - 34022 - 15126  
2 mm - 34022 - 20126

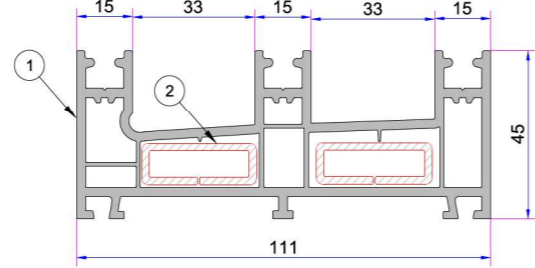

- Üç Raylı Sürme Kasa Profili**  
P.A.222.1103.600
- Destek Sacı (10x31)**  
1,2mm - 34022 - 12107  
1,5mm - 34022 - 15107  
2 mm - 34022 - 20107

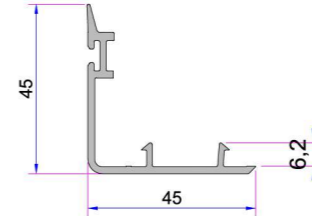
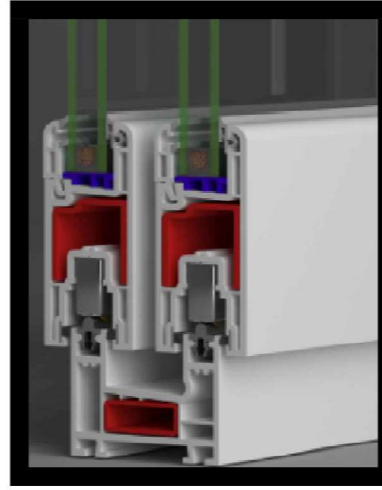

Süper Kanat Arka Kapama Profili  
P.A.222.5700.600

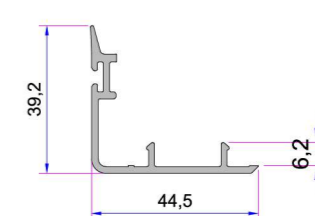

Kanat Arka Kapama Profili  
P.A.222.5708.600

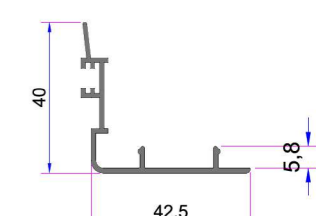

Alm. Kanat Arka Kapama Profili  
AD16-031

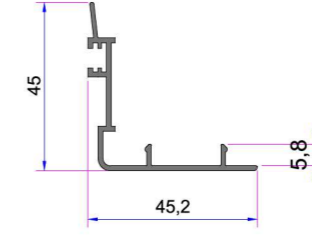

Alm. Süper Kanat Arka Kapama Profili  
AD16-032

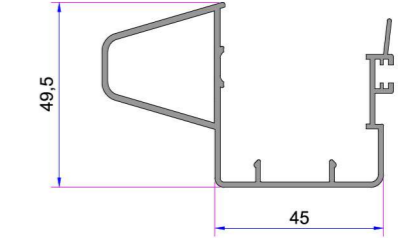

Alm. Kanat Arka Kapama Griyaj Profili  
Kalıp Yeni Yapılacak

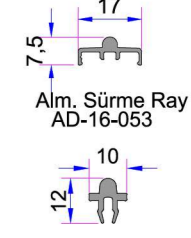

Alm. Sürme Ray  
AD16-053

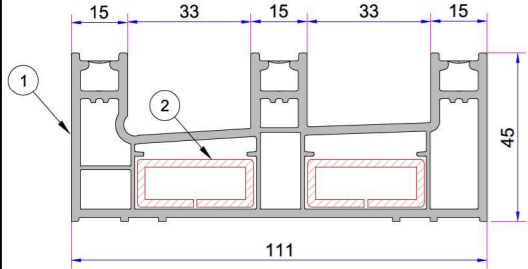

- Üç Raylı Sürme Kasa Profili (Yeni)**  
P.A.222.1112.600
- Destek Sacı (13x31)**  
1,2mm - 34022 - 12126  
1,5mm - 34022 - 15126  
2 mm - 34022 - 20126

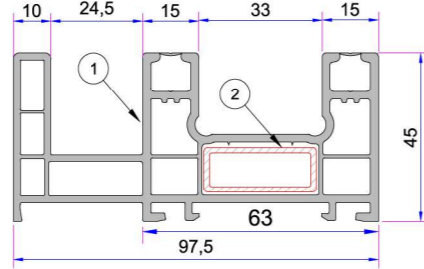

- Sürme Sineklik Raylı Kasa Profili**  
P.A.222.1113.600
- Destek Sacı (12x30)**  
1,2mm - 34022 - 12107  
1,5mm - 34022 - 15107  
2 mm - 34022 - 20107

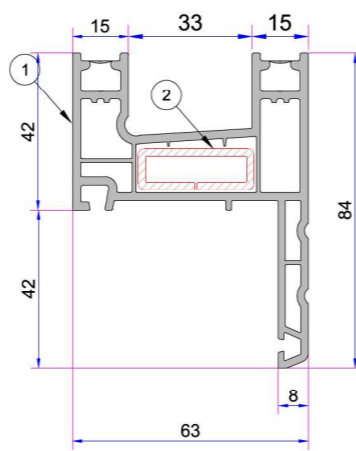

- Pervazlı Sürme Çift Raylı Kasa Profili**  
P.A.222.1107.600
- Destek Sacı (10x31)**  
1,2mm - 34022 - 12107  
1,5mm - 34022 - 15107  
2 mm - 34022 - 20107

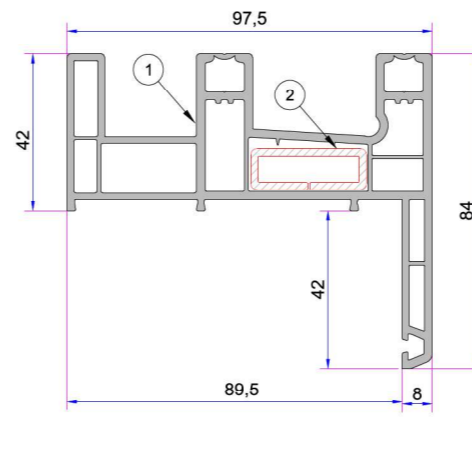

- Sürme Pervazlı Sineklik Kasa Profili**  
P.A.222.1109.600
- Destek Sacı (10x31)**  
1,2mm - 34022 - 12107  
1,5mm - 34022 - 15107  
2 mm - 34022 - 20107

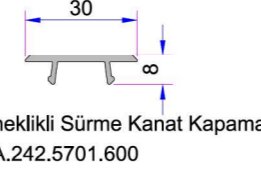

Sineklikli Sürme Kanat Kapama  
P.A.242.5701.600

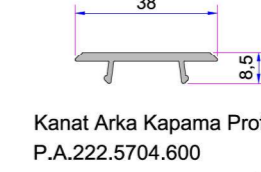

Kanat Arka Kapama Profili  
P.A.222.5704.600

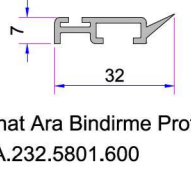

Kanat Ara Bindirme Profili  
P.A.232.5801.600



Kısa Bağ Profili  
P.A.099.5003.600

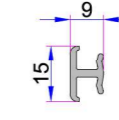

Ortak Kısa Bağ Profili  
P.A.099.5004.600

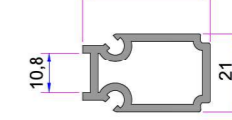

Alm. Çift Ray Adaptörü  
AD16-011

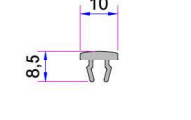

Kasa Kanal Kapama  
P.A.232.5703.600

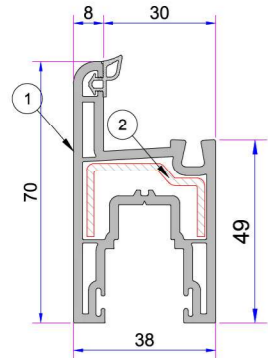

- Sürme Kanat Profili**  
P.A.222.2300.600
- Destek Sacı (19,5x31,5x15,5)**  
1,2mm - 34022 - 12026  
1,5mm - 34022 - 15026  
2 mm - 34022 - 20026

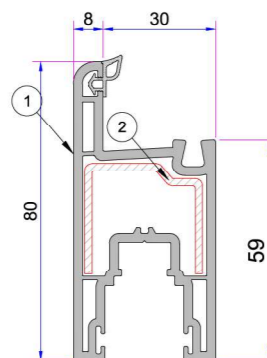

- Süper Sürme Kanat Profili**  
P.A.222.2304.600
- Destek Sacı (29,5x31,5x25,5)**  
1,2mm - 34022 - 12027  
1,5mm - 34022 - 15027  
2 mm - 34022 - 20027

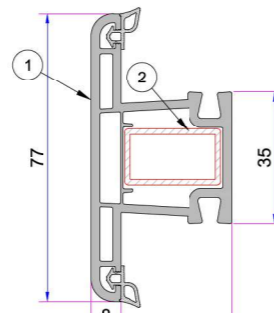

- Sürme Kanat İçi Orta Kayıt Profili**  
P.A.222.3201.600
- Destek Sacı (26x15)**  
1,2mm - 34022 - 12127  
1,5mm - 34022 - 15127  
2 mm - 34022 - 20127

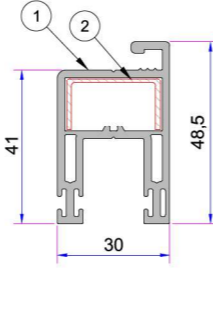

- Sürme Sineklik Kanat Profili**  
P.A.242.2305.600
- Destek Sacı (13x25x13)**  
1,2mm - 34022 - 12008  
1,5mm - 34022 - 15008  
2 mm - 34022 - 20008

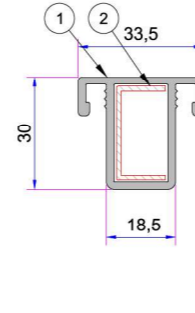

- Sürme Sineklik Orta Kayıt Profili**  
P.A.242.3200.600
- Destek Sacı (13x25x13)**  
1,2mm - 34022 - 12008  
1,5mm - 34022 - 15008  
2 mm - 34022 - 20008

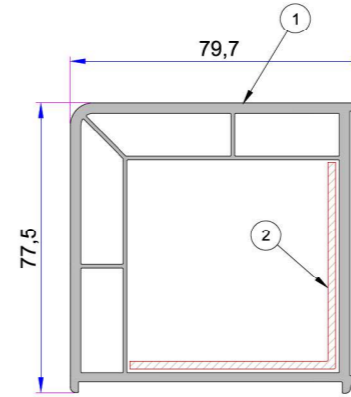

- 90° Köşe Profili**  
P.A.070.5100.600
- Destek Sacı (55x55)**  
1,2mm - 34022 - 12305  
1,5mm - 34022 - 15305  
2 mm - 34022 - 20305

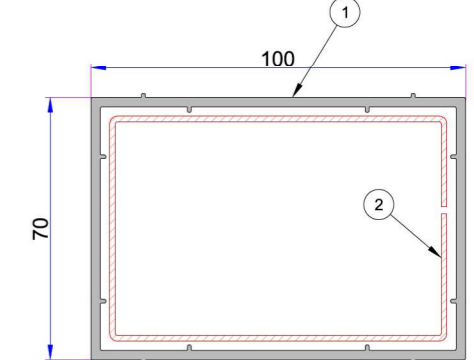

- Kutu Profili (70x100)**  
P.A.070.5202.600
- Destek Sacı (60x90)**  
1,2mm - 34022 - 12121  
1,5mm - 34022 - 15121  
2 mm - 34022 - 20121

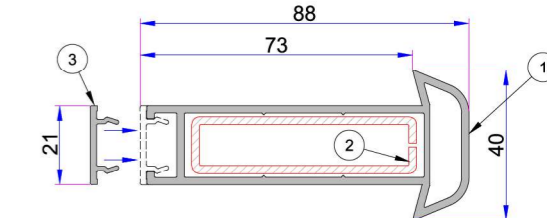

- Üniversal Kalın Bağ Profili**  
P.A.058.5000.600
- Destek Sacı (15x60)**  
1,2mm - 34022 - 12123  
1,5mm - 34022 - 15123  
2 mm - 34022 - 20123
- Üniversal Kalın Bağ Kapak Profili**  
P.A.058.5707.600

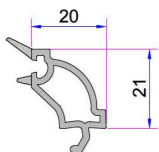

4mm Tek Cam Çıtası  
P.A.101.4102.600.0.HC

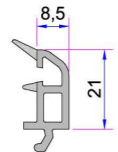

15mm Çift Cam Çıtası  
P.A.532.4400.600.0.HC

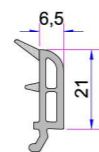

17mm Çift Cam Çıtası  
P.A.532.4500.600.0.HC

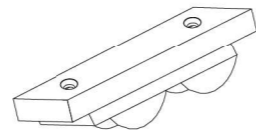

Sürme Araba  
34009-18030

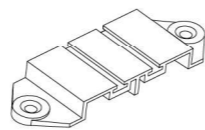

Çift Ray Sızdırmazlık Parçası  
34009-27010

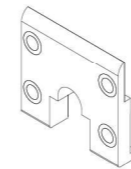

Sürme Kanat Bitiş Parçası  
34009-47010

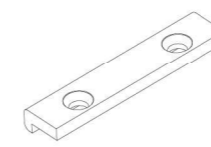

Sürme Ray Üst Yatak Parçası  
34009-37010

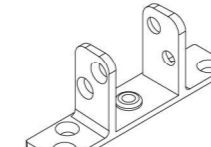

Kanat İçi Orta Kayıt Bağlantı Takozu  
21283.0000.0.2