



 **ADOWIN**[®]
EKO SÜRME SERİSİ
PVC PROFİL SİSTEMİ



TEKNİK

EKO SÜRME SERİ

Profil Geniřlięi: 63mm Çift Raylı Kasa, 111 mm Üç Raylı Kasa ve 38 mm Sürme Kanat

Odacık Sayısı: 3

Profil Sınıfı: B Class (TS EN 12608-1)

Conta Sistem: Kıl fitil izolasyonlu sistem

Cam Kalınlıkları (mm): 4 - 6, 15, 17 mm

- 1 Çift raylı ve üç raylı kasa seçeneęi.
- 2 Üçlü Kanat Seçeneęi.
- 3 Tek cam ve çift cam seçeneęi.

AÇIKLAMA

- 63 mm genişlikte çift raylı kasa, 111 mm genişlikte üç raylı kasa ile 38 mm genişlikte sürme kanat profili.
- Üç geniş odacığı ve şaşırtmalı su tahliye sistemi kasası sayesinde mükemmel su izolasyonu sağlar.
- Farklı kalınlıklarda gri contalı çita ile tek cam (4-6 mm) ve ısıcam (15 - 17 mm) uygulama imkanı.
- Panjurlu ve Panjursuz uygulama seçenekleri.
- Ahşap desenli laminasyon uygulaması.

RENK SEÇENEKLERİ



ALTIN MEŞE
ST 500



KOYU MEŞE
ST 501



BATAKLIK MEŞE
ST 503



AÇIK MEŞE
ST 515



KUM GRI
AS 509



GRI
ST 507



ANTRASİT GRI
ST 508

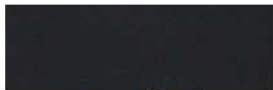

ANTRASİT GRI
AS 508



MAUN
ST 504



KREM
AS 057

EKO SÜRME SERİSİ PVC PROFİL SİSTEMİ

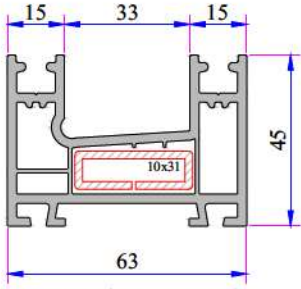

Çift Raylı Kasa Profili
P.A.222.1100.600.0.00.01

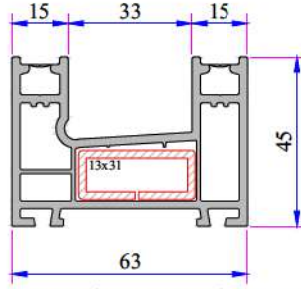

Çift Raylı Kasa Profili (Yeni)
P.A.222.1111.600.0.00.01

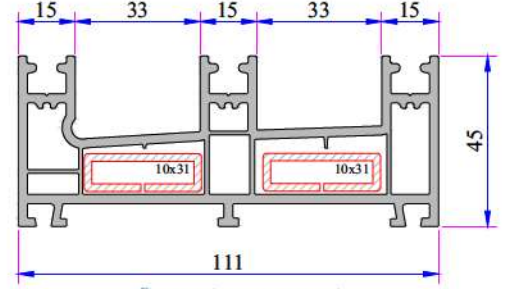

Üç Raylı Kasa Profili
P.A.222.1103.600.0.00.01

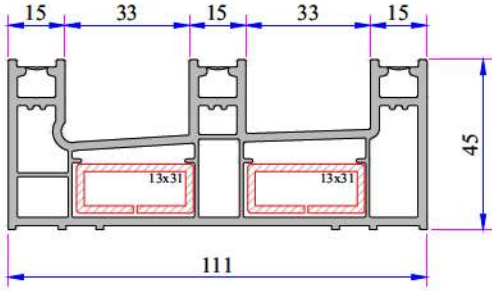

Üç Raylı Kasa Profili (Yeni)
P.A.222.1112.600.0.00.01

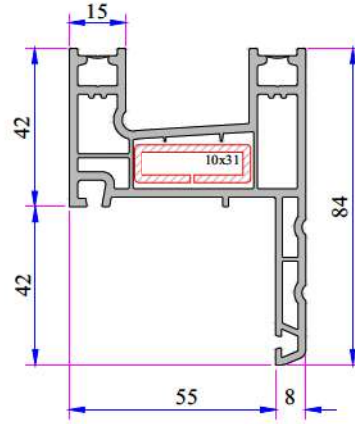

Çift Raylı Pervazlı Kasa Profili
P.A.222.1107.600.0.00.01

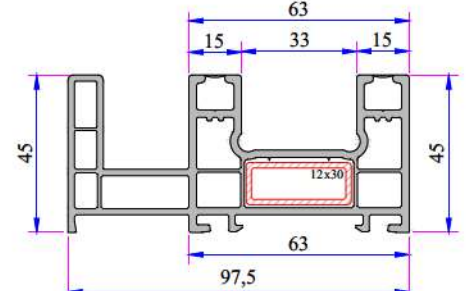

Sürme Sineklik Raylı Kasa Profili
P.A.222.1113.600.0.00.01

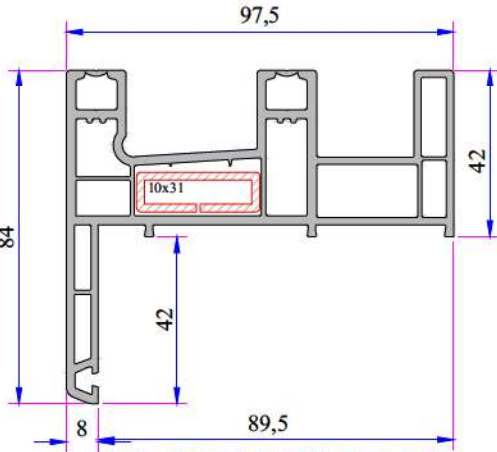

Sürme Pervazlı Sineklik Kasa Profili
P.A.222.1109.600.0.00.01

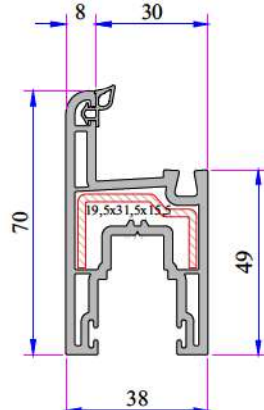

Sürme Kanat Profili
P.A.222.2300.600.0.BC.01

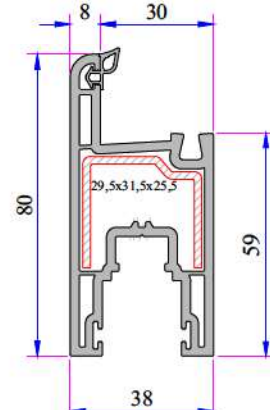

Süper Sürme Kanat Profili
P.A.222.2304.600.0.BC.01

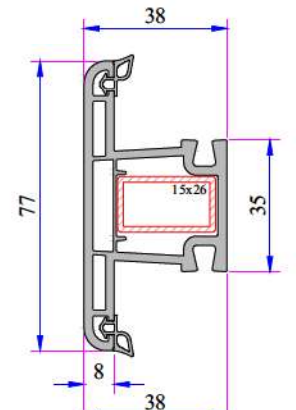

Kanat İçi Orta Kayıt Profili
P.A.222.3201.600.0.BC.01

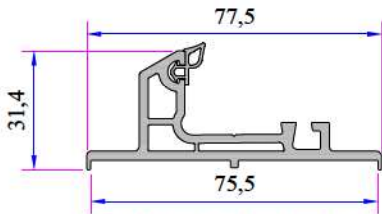

Çift Ray Adaptör Profili
P.A.232.5800.600.0.BC.19

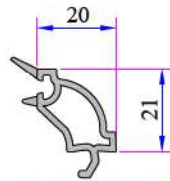

Tek Cam Çıtası 4-6mm
P.A.101.4002.600.0.HC

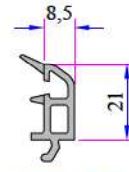

Çift Cam Çıtası 15mm
P.A.532.4400.600.0.HC

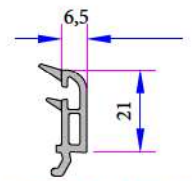

Çift Cam Çıtası 17mm
P.A.532.4500.600.0.HC



Üniversal Kalın Bağ Kapak Profili
P.A.058.5707.600

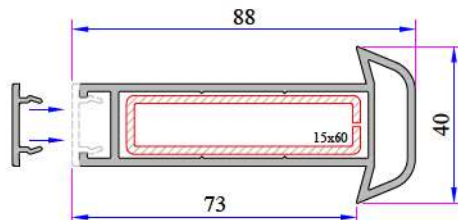

Üniversal Kalın Bağ Profili
P.A.058.5000.600.0.19

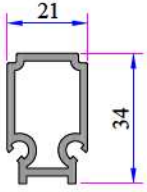

Alm. Çift Ray Adaptörü
16011.601.5.11.9016

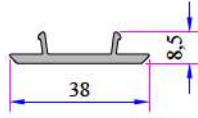

Kanat Kapama Profili
P.A.222.5704.600

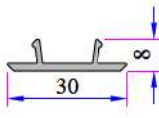

Sineklik Kanat Kapama Profili
P.A.242.5701.600

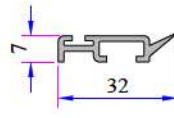

Kanat Ara Bindirme Profili
P.A.232.5801.600

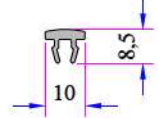

Kasa Kanal Kapama Profili
P.A.232.5703.600

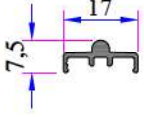

Şapkalı Alm. Ray Profili
16053.601.5.2.0.0000



Alm. Ray Profili
16014.601.5.0.0.0000

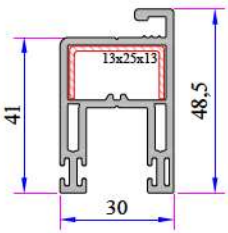

Sürme Sineklik Kanat Profili
P.A.242.2305.600.0.00.03

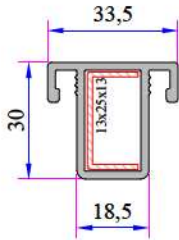

Sineklik Orta Kayıt Profili
P.A.242.3200.600.0.00.03

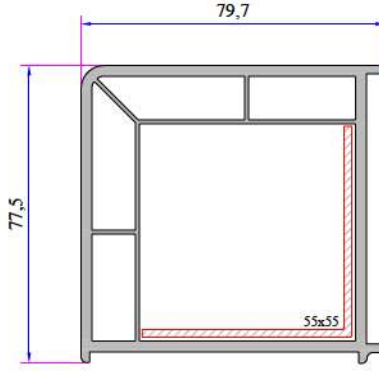

90° Köşe Dönüş Profili
P.A.070.5100.600.0.00.19

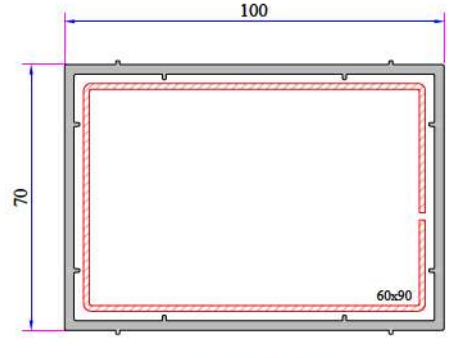

Kutu Profili 70x100mm
P.A.070.5202.600.0.00.19

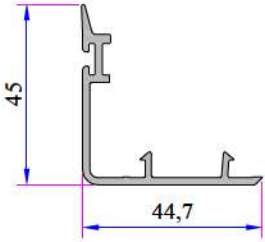

PVC Süper Kanat Arka Kapama
P.A.222.5700.600.0.00.19

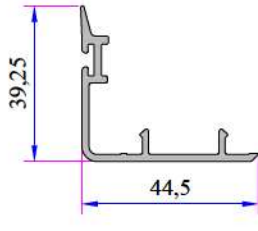

222 Sürme Alın Kapama
P.A.222.5708.600

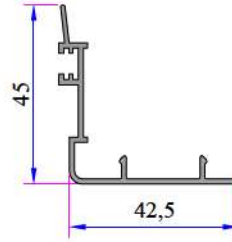

Alm. Süper Kanat Arka Kapama
16032.601.5.11.9016

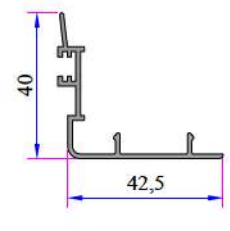

Alm. Kanat Arka Kapama
16031.601.5.11.9016

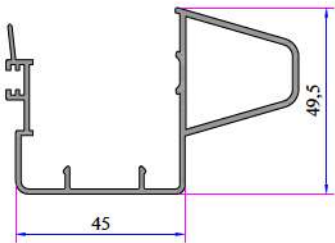

Alm. Kanat Kapama Griyaj Profili (Yeni Yapılacak)

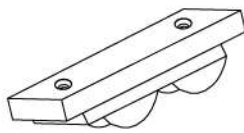

Sürme Araba
34009-18030

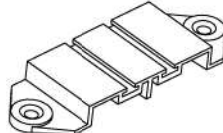

Çift Ray Sızdırmazlık Parçası
34009-27010

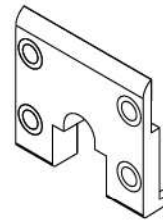

Sürme Kanat Bitiş Parçası
34009-47010

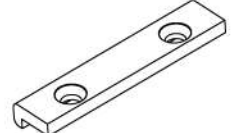

Sürme Ray Üst Yataklık Parçası
34009-37010

Eko Sürme Destek Sacı Profilleri

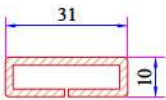

Çift Raylı Kasa - Üç Raylı Kasa - Sürme Pervazlı Sineklik Kasa - Çift Raylı Pervazlı Kasa Profili Destek Sacı
34022-12107

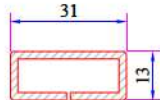

Çift Raylı Kasa - Üç Raylı Kasa Profili Destek Sacı
34022-12126

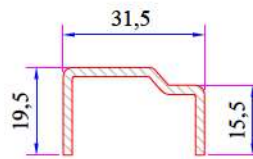

Sürme Kanat Profili Destek Sacı
34022-15026

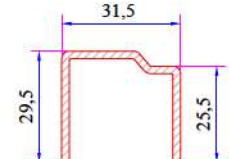

Süper Sürme Kanat Profili Destek Sacı
34022-15027

EKO SÜRME SERİSİ PVC PROFİL SİSTEMİ

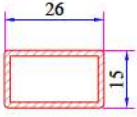

Kanat İçi Orta Kayıt Profili
Destek Sacı
34022-12127

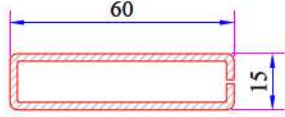

Üiversal Kalın Bağ Profili Destek
Sacı
34022-12123

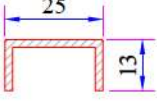

Sürme Sineklik Kanat - Orta
Kayıt Profili Destek Sacı
34022-12008

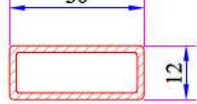

Sürme Sineklik Raylı Kasa Profili
Destek Sacı
34022-12115

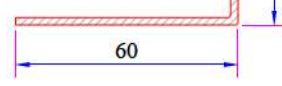

90° Köşe Dönüş Profili Destek
Sacı
34022-12306

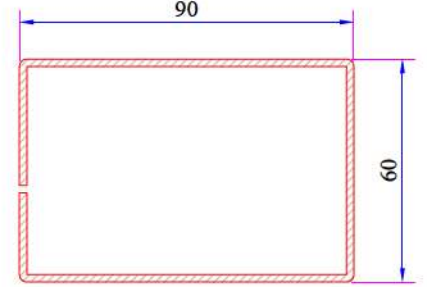

70x100mm Kutu Profili Destek
Sacı
34022-12121

Eko Sürme Montajlar

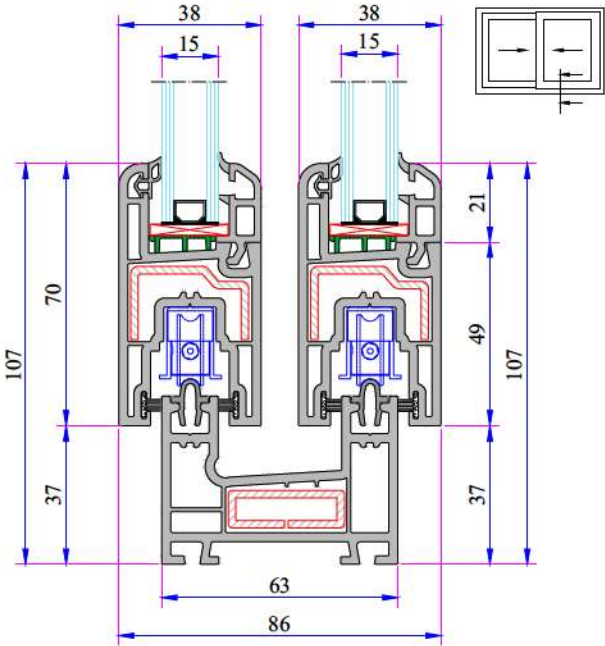

Çift Ray Sürme Kasa - Sürme Kanat
Montajı

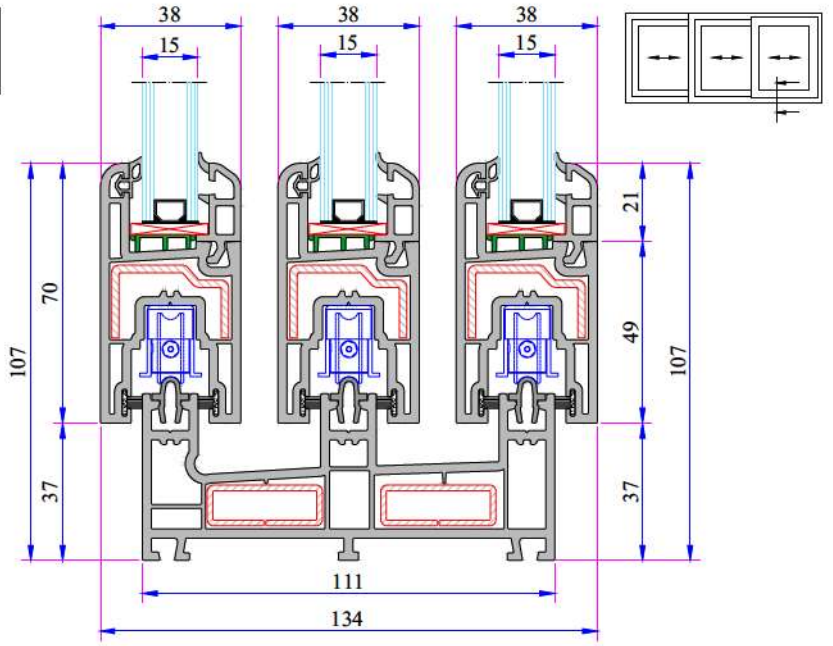

Üç Raylı Kasa - Sürme Kanat Montajı

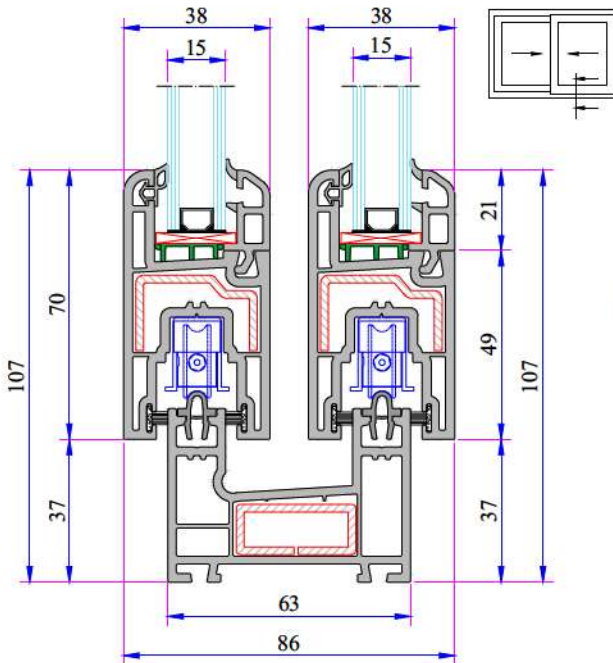

Çift Raylı Kasa (Yeni) - Sürme Kanat
Montajı

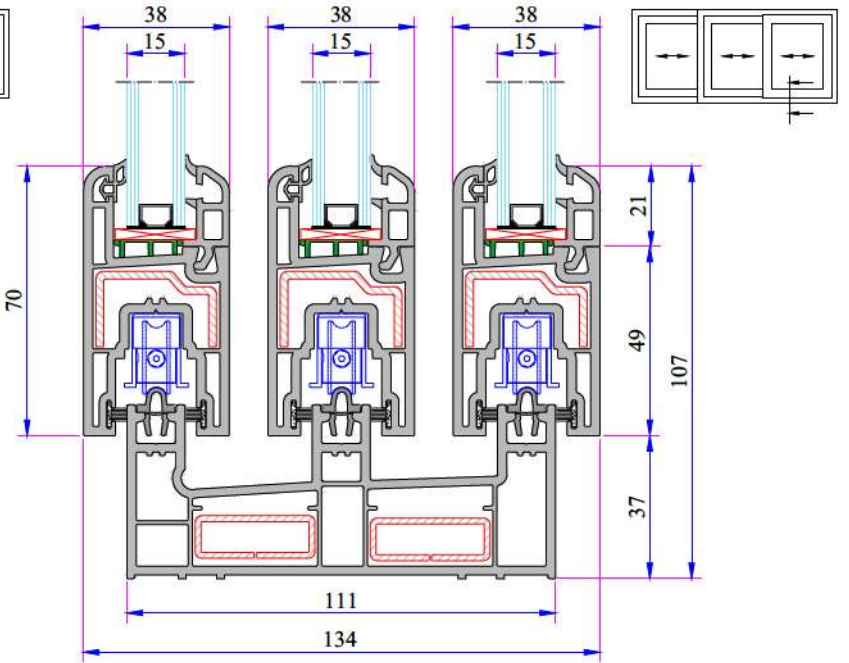

Üç Raylı Kasa - Sürme Kanat Montajı

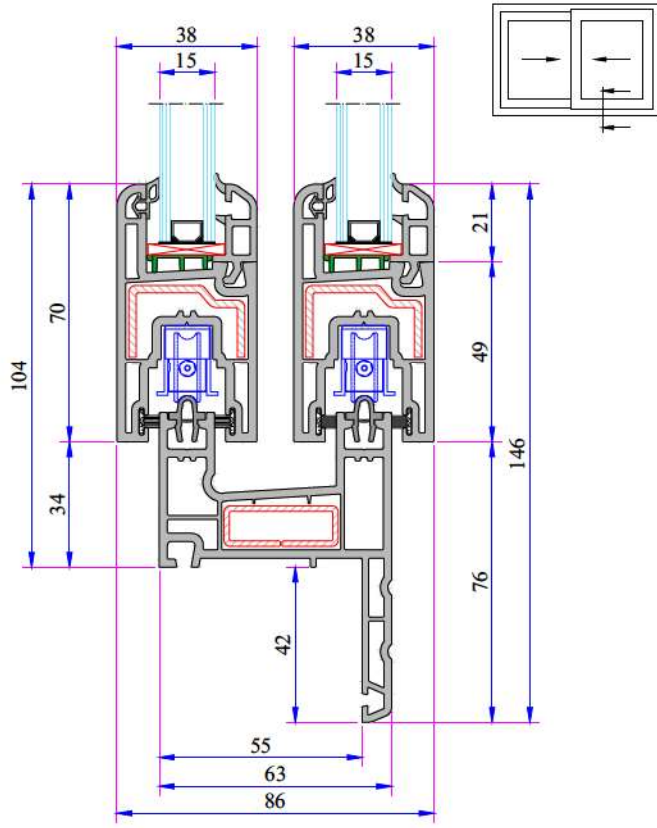

Pervazlı Çift Raylı Kasa - Sürme Kanat Montaj Detayı

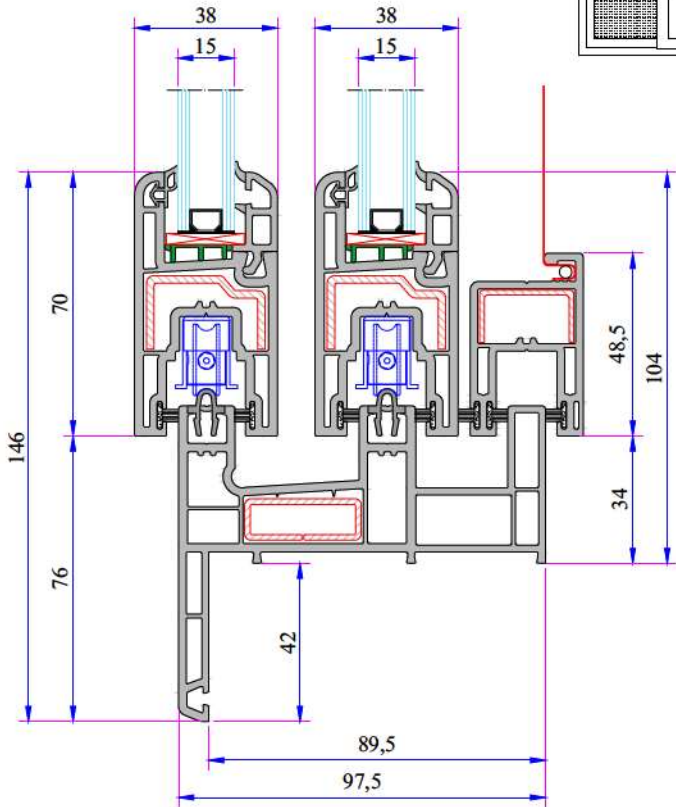

Sürme Pervazlı Sineklik Kasa - Sürme Kanat Montaj Detayı

Çift Ray Adaptör Profili Montajı

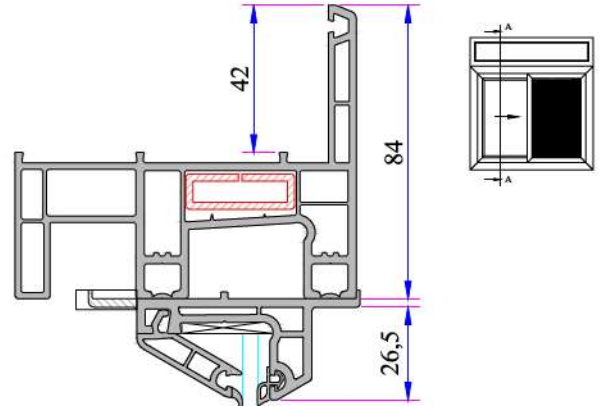

Orta Kayıt Profili İçin Kesilecek Kısım

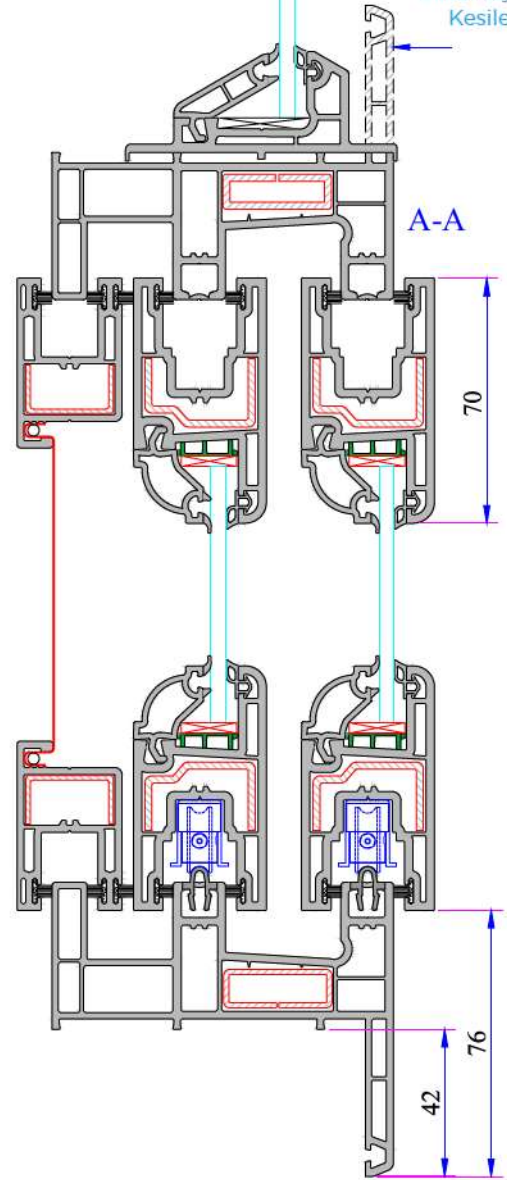

EKO SÜRME SERİSİ PVC PROFİL SİSTEMİ

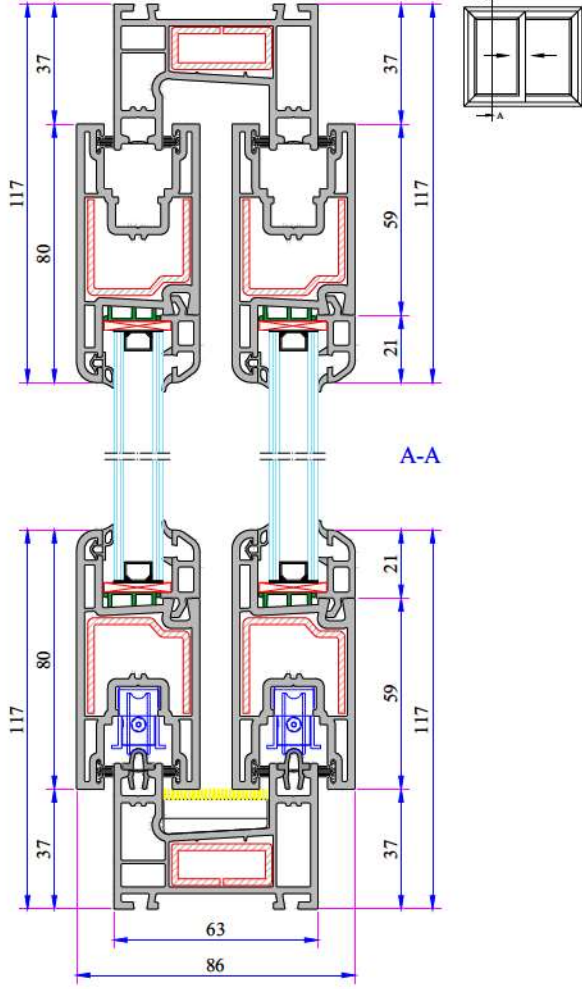

Çift Raylı Kasa İkili Kanat Montaj Detayı

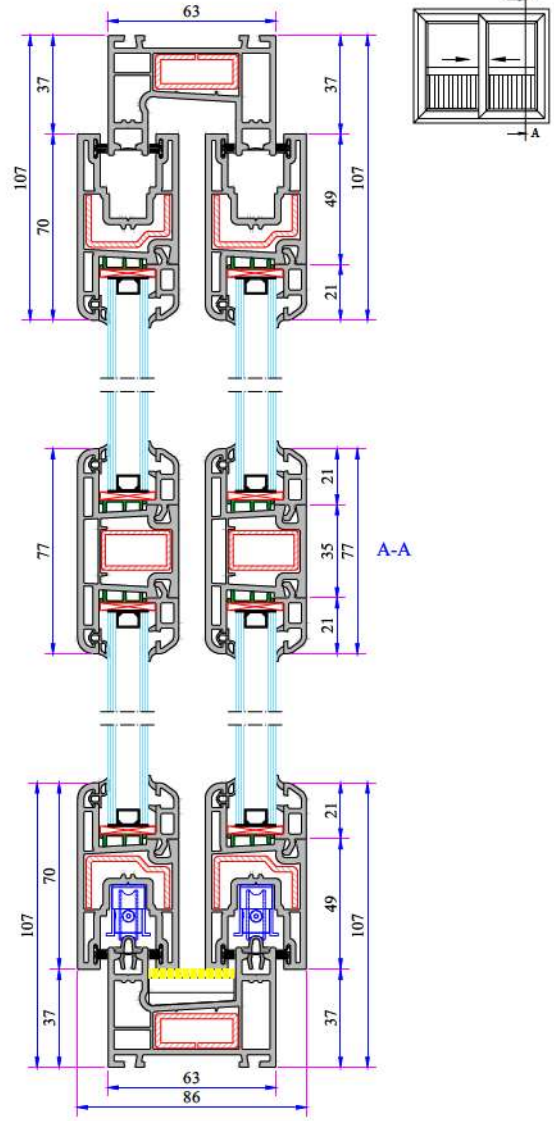

Kanat İçi Orta Kayıt Montaj Detayı

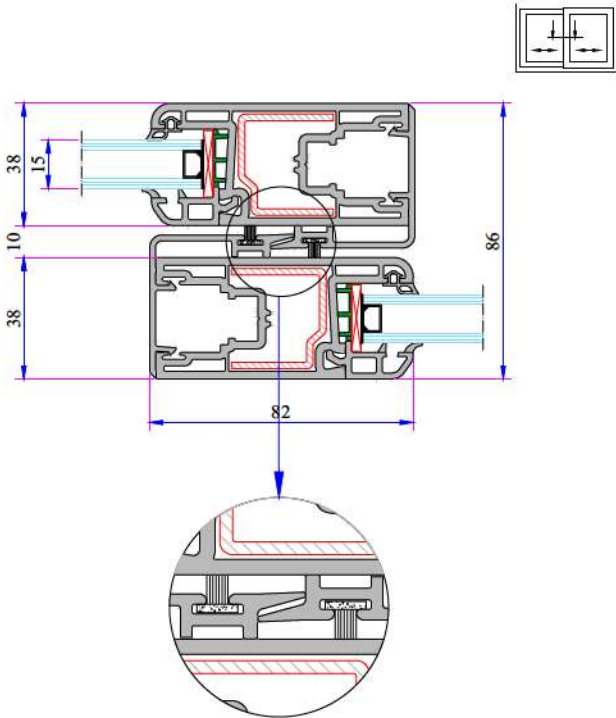

Süper Sürme Kanat Arka Kapama Montajı

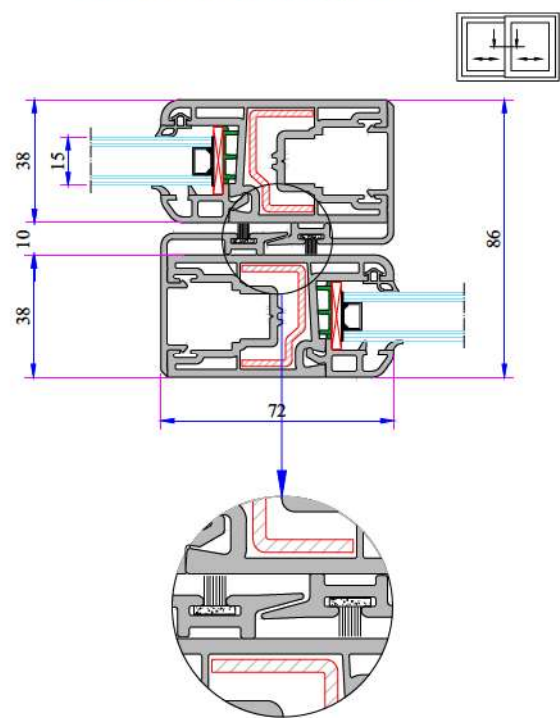

Sürme Kanat Arka Kapama Montajı

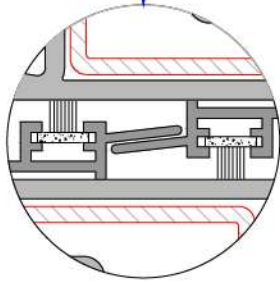
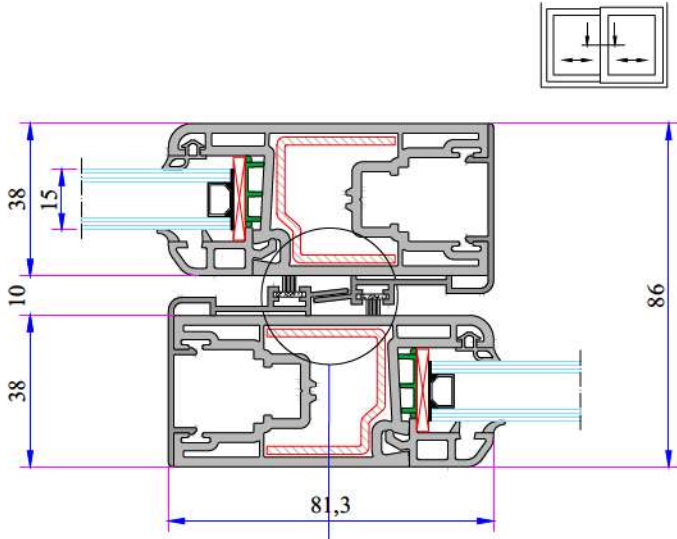

Süper Sürme Kanat Alm. Arka Kapama
Montajı

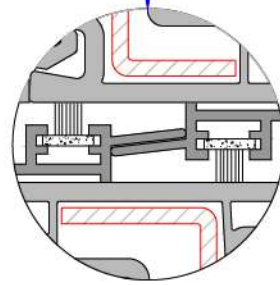
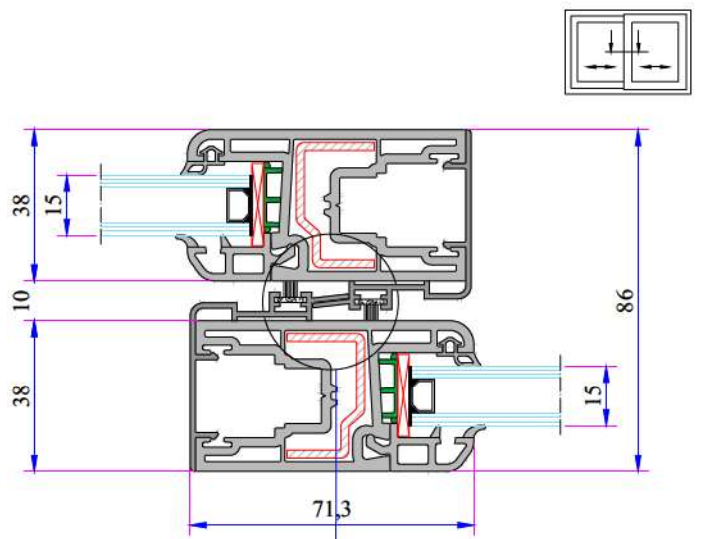

Sürme Kanat Alm. Arka Kapama
Montajı

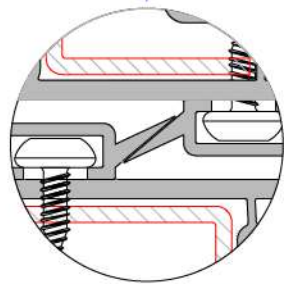
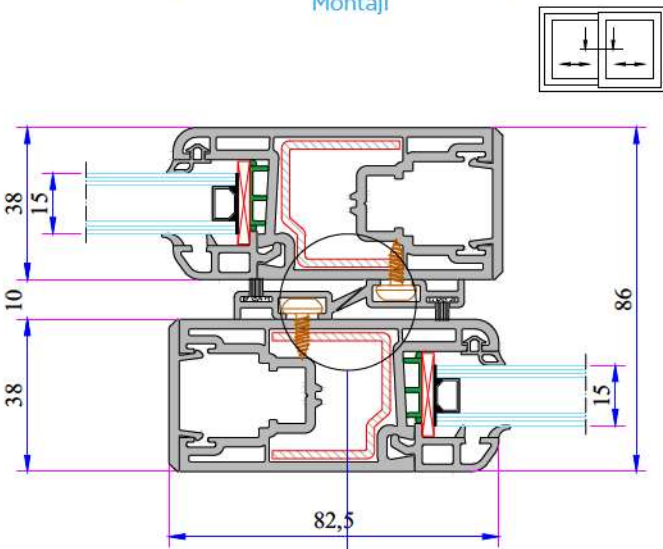

Süper Sürme Kanat Arka Kapama
Montajı

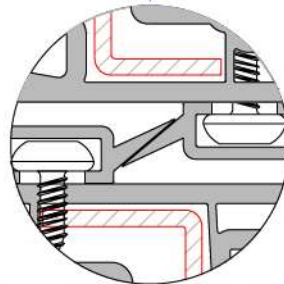
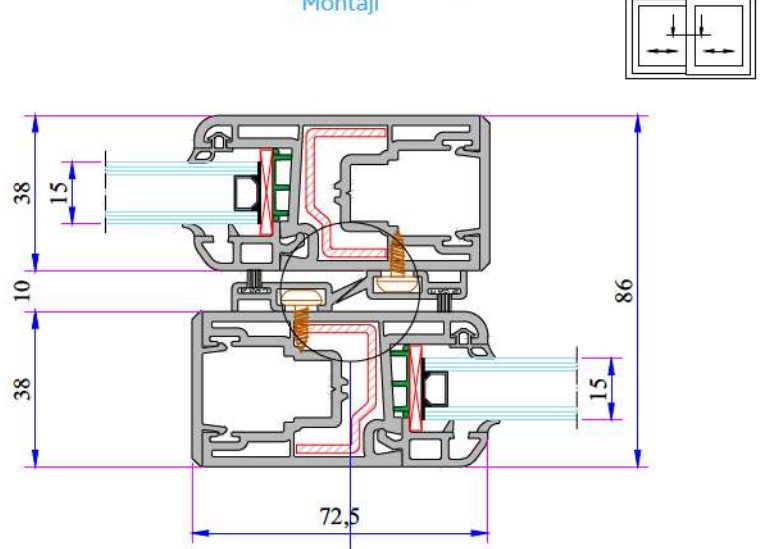

Sürme Kanat Arka Kapama Montajı

Süper Sürme Kanat - Alm. Arka
Kapama Griyajı Montajı (Yeni Yapılacak)

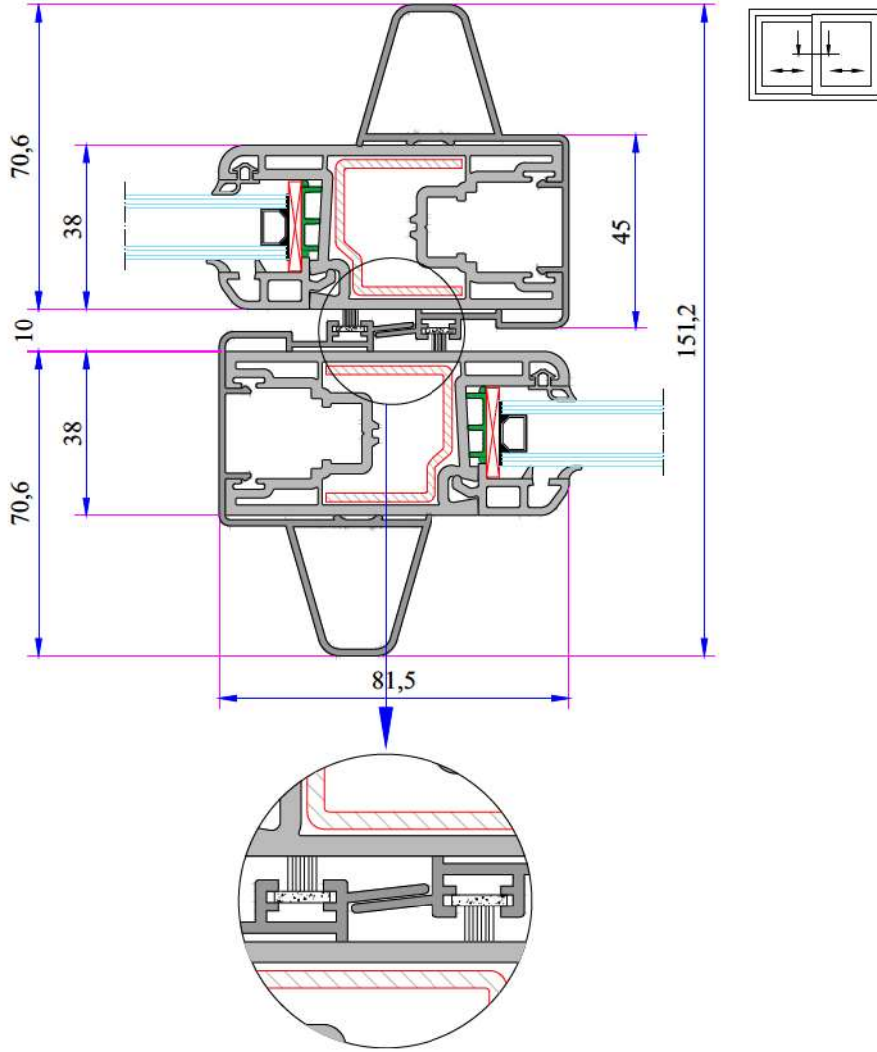

Alm. Çift Ray Adaptörü Montaj Detayı

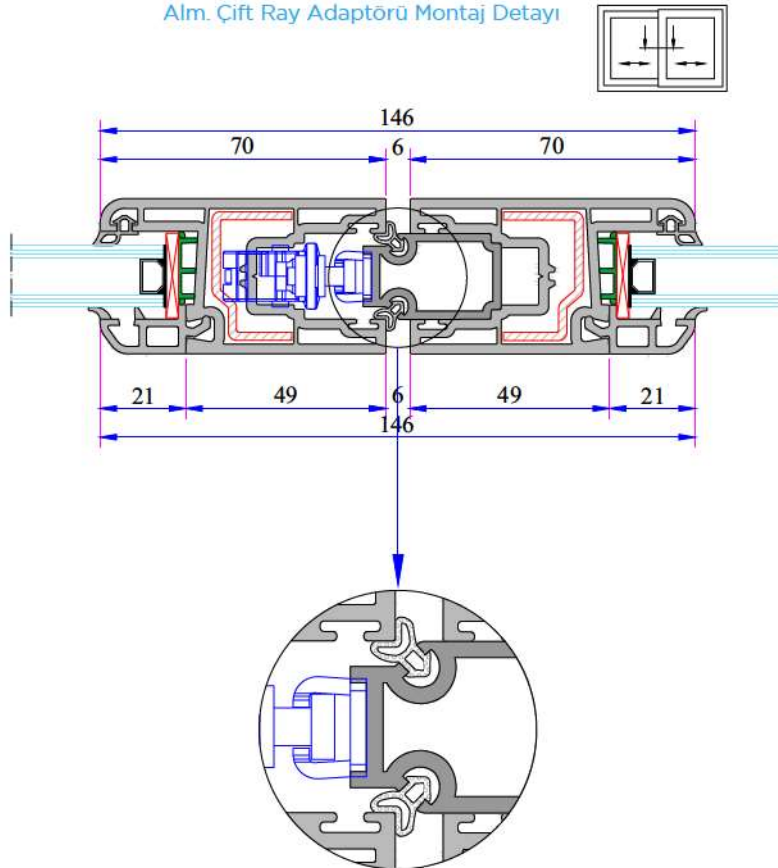



FACTORY

Antalya Organize Sanayi Bölgesi 2.Kısım Mah. 21.Cadde No:3

07040 Döşemealtı / ANTALYA / TURKEY

Tel : +90 242 236 20 00 · Faks : +90 242 236 20 90 · Email : info@adowin.com.tr

